

LK HydronicGroup C/C 125 867



TECHNICAL DATA

Voltage	230 VAC 50/60 Hz
Power consumption	10-75 W depending on pump speed
Working temperature	Min. 5 °C/Max. 100 °C
Ambient temp.	Min. 5 °C/Max. 58 °C
Max. working pressure	1,0 MPa (10 bar)
Media	Water - Glycol mixture max. 50%
Thread standard	Rp - female thread, G - male thread
Circulating pump	Wilo PARA 25-180/6-43/SC-12 Wilo PARA 25-180/8-75/SC-12
Material, valve body	Brass EN 12165 CW617N
Material, insulation	Expanded Polypropylene EPP

LK HydronicGroup 867 is a pump group with a four way mixing valve, LK 830 ThermoMix® B.

The pump group has a 4-way bivalent mixing valves that is designed for heating systems, where energy is taken from two heating units connected in series or parallel or for storage tank systems where energy is extracted from two levels. The pump group should be equipped with an automatic control unit to ensure that the most favourable heat source is prioritised at all times.

LK HydronicGroup comprises a highly efficient circulation pump, insulation, wall mounting bracket and two ball valves with thermometer, of which the ball valve on the return side has an integrated check valve.

Die LK HydronicGroup 867 ist eine Pumpengruppe mit einem 4-Wege Mischventil, LK 830 ThermoMix® B.

Die Pumpengruppe hat einen 4-Wege bivalenten Mischer, der in Heizsystemen mit zwei Reihen oder parallel verbundenen Heizquellen eingesetzt wird. Der Mischer ist ebenfalls für Pufferspeicher mit Schichtung geeignet.

Die LK HydronicGroup besteht unter anderem aus einer hocheffektiven Zirkulationspumpe, Isolierung, Konsole für die Wandmontage sowie zwei Kugelventilen mit Thermometer. Das Kugelventil für die Rücklaufseite hat ein integriertes Rückschlagventil.

DONNÉES TECHNIQUES

Tension nominale	230 VAC 50/60 Hz
Puissance maxi chaudière	10-75 W suivant position circulateur
Température de service	Min. 5 °C/Max. 100 °C
Température d'ambiance	Min. 5 °C/Max. 58 °C
Pression de service max.	1,0 MPa (10 bar)
Fluide	Eau - Glycol max. 50%
Filetage standard	Rp - filetage femelle, G - filetage mâle
Circulateur	Wilo PARA 25-180/6-43/SC-12 Wilo PARA 25-180/8-75/SC-12
Matériau, corps de vanne	Laiton EN 12165 CW617N
Matériau, isolation	Polypropylène Expandé EPP

LK HydronicGroup 867 est un groupe de pompes avec une vanne mélangeuse à quatre voies, LK 830 ThermoMix® B.

Le groupe de pompes est destiné à garantir à la fois une répartition optimale de la température dans le réservoir accumulateur et une forte température de retour vers la chaudière, ce qui augmente l'efficacité de l'installation.

LK HydronicGroup comprend entre autres une pompe de circulation très efficace, une isolation, une console pour le montage mural, et deux robinets à boisseau sphérique avec un thermomètre, dont le robinet à boisseau sphérique du côté retour dispose d'un clapet antiretour.

TECHNISCHE DATEN

Nennspannung	230 VAC 50/60 Hz
Leistungsaufnahme	10-75 W abhängig von Pumpendrehzahl
Arbeitstemperatur	Min. 5 °C/Max. 100 °C
Umgebungstemperatur	Min. 5 °C/Max. 58 °C
Max. Arbeitsdruck	1,0 MPa (10 bar)
Flüssigkeit	Wasser - Glykol max. 50%
Gewindenorm	Rp - Innengewinde, G - Aussengewinde
Umwälzpumpe	Wilo PARA 25-180/6-43/SC-12 Wilo PARA 25-180/8-75/SC-12
Material, Gehäuse	Messing EN 12165 CW617N
Material, Isolierung	Expandiertes Polypropylen EPP

DATI TECNICI

Voltaggio	230 VAC 50/60 Hz
Consumo	10-75 W secondo la velocità della pompa
Temperatura di esercizio	Min. 5 °C/Max. 100 °C
Temperatura ambiente	Min. 5 °C/Max. 58 °C
Pressione massima di esercizio	1,0 MPa (10 bar)
Fluidi	Acqua. Miscela Acqua - Glicole max. 50%
Filettatura standard	Rp - filettatura femmina, G - filettatura maschio
Pompa di ricircolo	Wilo PARA 25-180/6-43/SC-12 Wilo PARA 25-180/8-75/SC-12
Materiale, corpo valvola	Ottone EN 12165 CW617N
Materialie, isolante	Polipropilene Espanso EPP

LK HydronicGroup 867 è un gruppo pompa con una valvola miscelatrice a quattro vie, LK 830 ThermoMix® B.

Il gruppo pompa è progettata per garantire un'ottimale stratificazione della temperatura nel sistema di accumulo e, contemporaneamente, garantire una elevata temperatura di ritorno verso la caldaia. Questo aumenta l'efficienza del sistema.

LK HydronicGroup comprende, fra l'altro, la pompa di ricircolo ad alta efficienza, l'isolamento, la staffa per montaggio a parete e due valvole a sfera con termometro, con la valvola a sfera sul lato di ritorno dotata di valvola di non ritorno integrata.

TEKNILLISET TIEDOT

Jännite	230 VAC 50/60 Hz
Tehonkulutus	10-75 W pumpun nopeudesta riippuen
Käyttölämpötila	Min. 5 °C/Maks. 100 °C
Ympäristön lämpötila	Min. 5 °C/Maks. 58 °C
Maks. käyttöpain	1,0 MPa (10 bar)
Siirtoneste	Vesi - Glykolia maks. 50%
Kierrestandardi	Rp - sisäkierre, G - ulkokierre
Kiertovesipumput	Wilo PARA 25-180/6-43/SC-12 Wilo PARA 25-180/8-75/SC-12
Materiaali, venttiilipesä	Messinki EN 12165 CW617N
Materiaali, eriste	Paisutettu Polypropeeni EPP

LK HydronicGroup 867 -pumppuryhmään kuuluu nelitieshunntiventtiilin LK 830 ThermoMix® B.

Pumppuryhmä varmistaa optimaalisen lämpökerrostumisen varaajasäiliössä ja korkean paluulämpötilan kattilaan, mikä suurentaa laitteiston hyötysuhdetta.

LK HydronicGroup koostuu mm. erittäin tehokkaasta kiertopumpusta, eristyksestä, seinäasennuskonsolista ja kahdesta kuulaventtiilistä, joissa on lämpömittari. Paluupuolen kuulaventtiilissä on integroitu suuntaventtiili.

TEKNISK DATA

Spänning	230 VAC 50/60 Hz
Effektförbrukning	10-75 W beroende av pumphastighet
Arbetstemperatur	Min. 5 °C/Max. 100 °C
Omgivningstemperatur	Min. 5 °C/Max. 58 °C
Max. arbetstryck	1,0 MPa (10 bar)
Media	Vatten - Glykolinblandning max. 50%
Gängstandard	Rp - invändig gänga, G - utvändig gänga
Cirkulationspump	Wilo PARA 25-180/6-43/SC-12 Wilo PARA 25-180/8-75/SC-12
Material, ventilhus	Mässing EN 12165 CW617N
Material, isolering	Expanderad Polypropylen EPP

LK HydronicGroup 867 är en pumpgrupp med en fyrvägs shuntventil, LK 830 ThermoMix® B.

Pumpgruppen har en 4-vägs bivalent shuntventil som är avsedd för värmesystem med två energikällor som är serie- eller parallellkopplade eller för ackumulatorsystem där energi tas från två nivåer. Shuntgruppen är utformad för att användas med en automatisk shuntreglering vilket säkerställer att den mest fördelaktiga värmekällan alltid prioriteras.

LK HydronicGroup består bland annat av högeffektiv cirkulationspump, isolering, konsol för väggmontage samt två kulventiler med termometer varav kulventil till retursidan har integrerad backventil.



LK 867 - PUMP CHARACTERISTICS

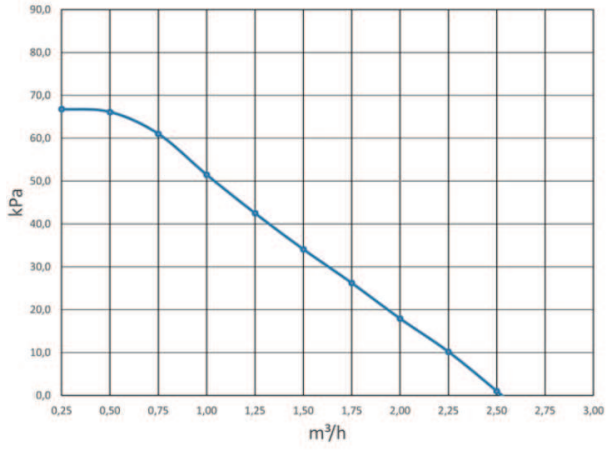

LK 867 - PUMP GROUP WITH LK 830 THERMOMIX® B

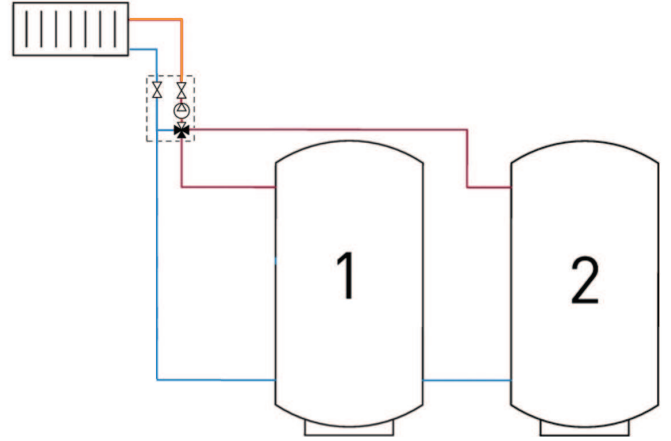

LK 867 - PUMP GROUP

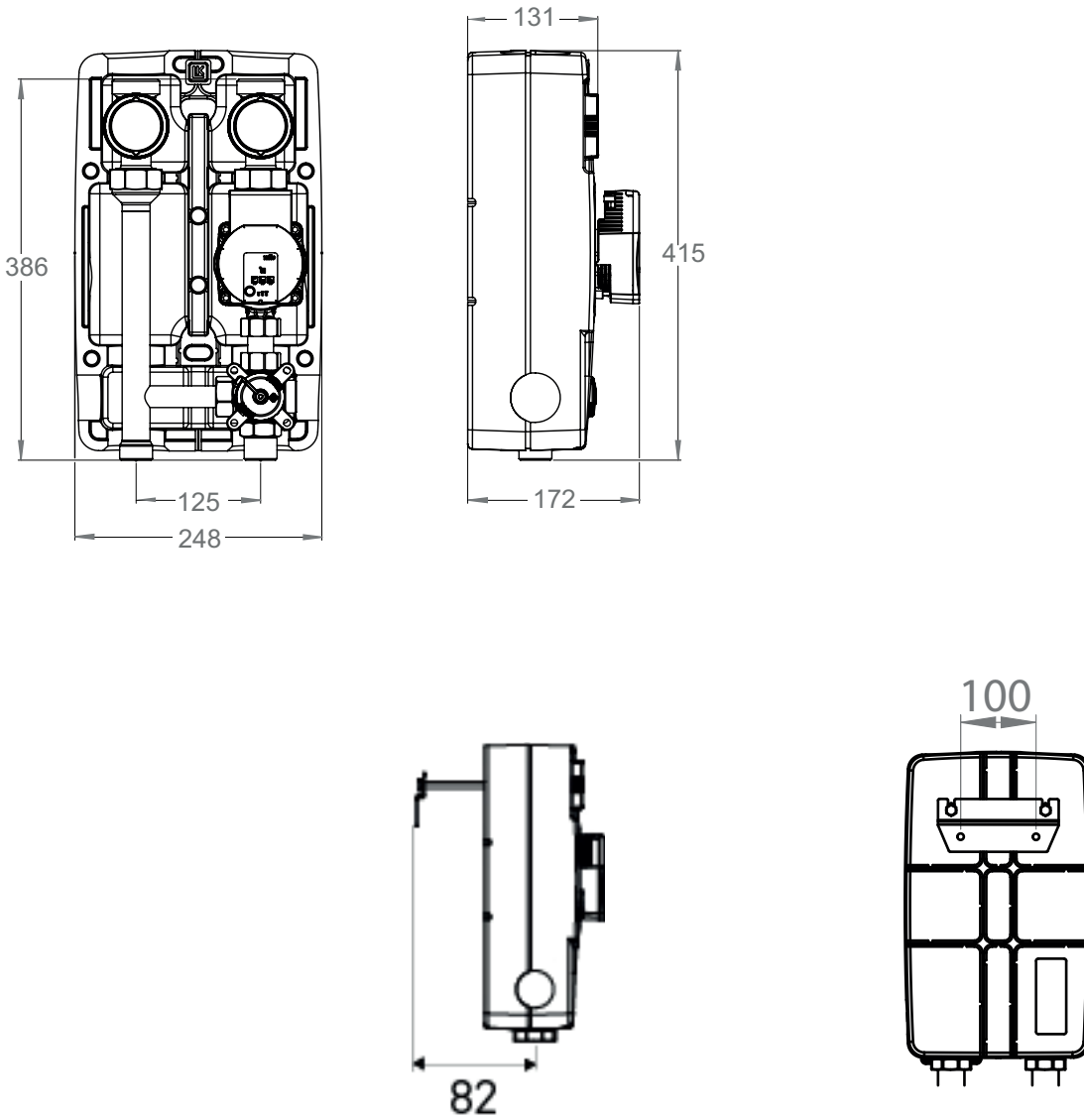

ACCESSORIES | ZUBEHÖR | ACCESSOIRES | ACCESSORI | LISÄVARUSTEET | TILLBEHÖR



Article no.	Article	Position
187203	Wilo PARA 25-180/8-75/SC-12 Circulating pump Zirkulationspumpe Circulateur Pompa di ricircolo Kiertoovesipumppu Cirkulations- pump	1
187322	Wilo PARA 25-180/6-43/SC-12 Circulating pump Zirkulationspumpe Circulateur Pompa di ricircolo Kiertoovesipumppu Cirkulations- pump	1
187323	Ballvalve, blue Kugelventil, blau Robinet à bille, bleu Valvola a sfera, blu Palloventtiili, sininen Kulventil, blå	2
187324	Ballvalve, red Kugelventil, rot Robinet à bille, rouge Valvola a sfera, rossa Palloventtiili, punainen Kulventil, röd	2
187325	Bracket Konsole Console Collettore Konsoli Konsol	3
187326	EPP Insulation EPP Isolierung EPP Isolation EPP Isolmento EPP eriste EPP Isolering	4
180588	Mixing Valve Kvs 6,3 Mischer Kvs 6,3 Vanne mélangeuse Kvs 6,3 Valvola michelatrice meccanica Kvs 6,3 Sekoitusventtiili Kvs 6,3 Shuntventil Kvs 6,3	5

Wilo-Para Quick start guide



WILO-PARA SELF CONTROL / INSTALLATION

One push-button

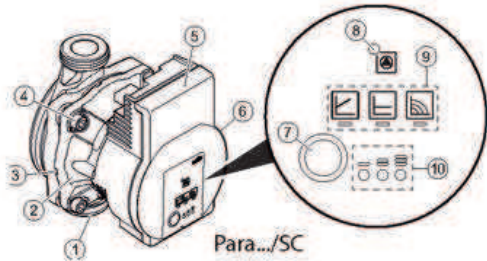

- 1 Pump housing with screwed connections
- 2 Glandless motor
- 3 Condensate drain openings (4x around circumference)
- 4 Housing screws
- 5 Control module
- 6 Rating plate
- 7 Green push button
- 8 Fault signal LED
- 9 Display for control mode ($\Delta p-v$, $\Delta p-c$, N constant)
- 10 Display for speed setting (I, II, III)

Electrical connection

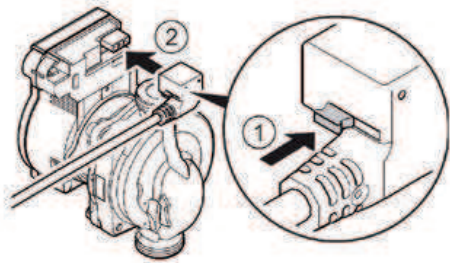

Standard factory setting

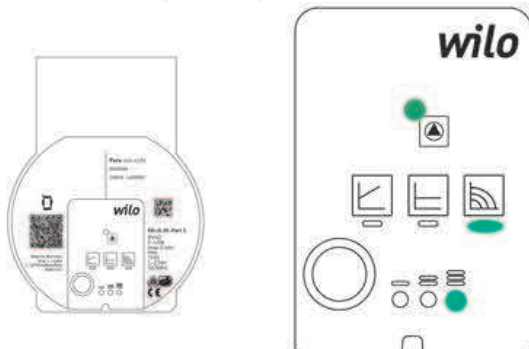

WILO-PARA SELF CONTROL / SETTING

Differential pressure variable $\Delta p-v$ (I, II, III)

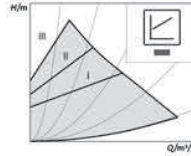

Recommended for two-pipe heating systems with radiators to reduce the flow noises at thermostatic valves.

Constant differential pressure $\Delta p-c$ (I, II, III)

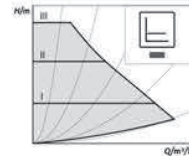

Recommended for underfloor heating or for large-sized pipes, applications without a variable pipe network curve (e.g. storage charge pumps) or single-pipe heating systems with radiators.

Constant speed (I, II, III)

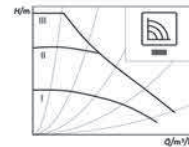

Recommended for systems with fixed system resistance requiring a constant volume flow and for replacement of AC pumps.

Push to change the pump setting

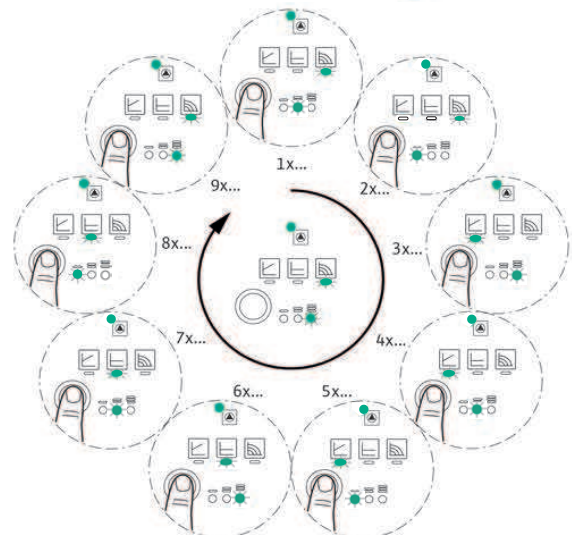

WILO-PARA SELF CONTROL / SMART FUNCTIONS

Air-venting mode

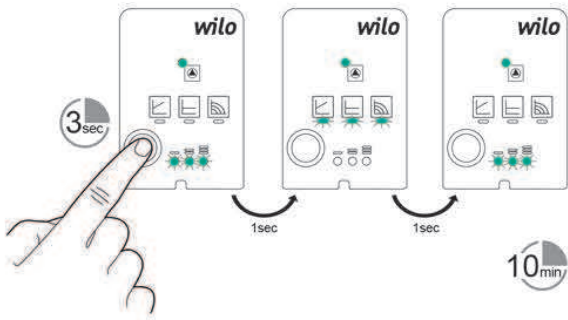

Manual restart

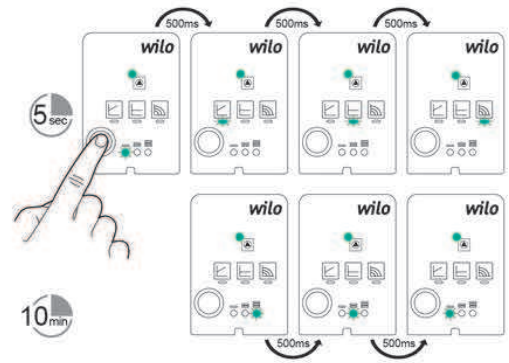

Lock & unlock

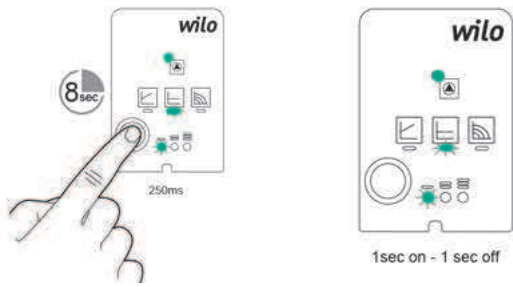



LK ARMATUR AB
www.lkarmatur.com

LK ARMATUR DEUTSCHLAND GMBH
www.lkarmatur.de